

LawnMaster®

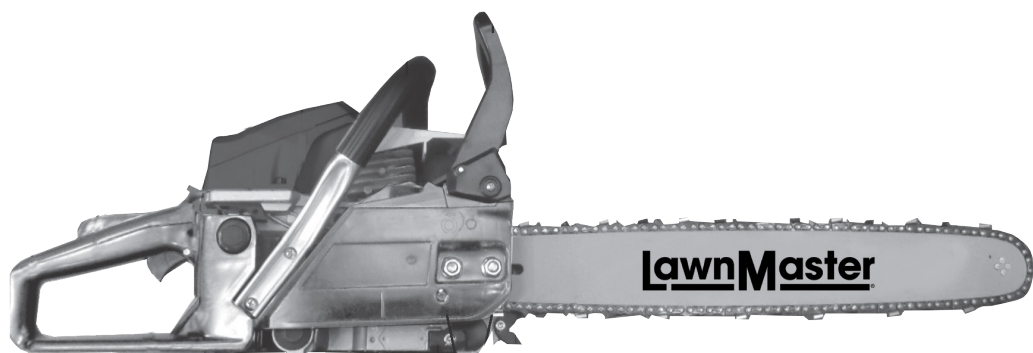

52CC **CHAINSAW**

SAFETY AND OPERATING MANUAL

PLEASE READ THIS MANUAL CAREFULLY BEFORE OPERATING THE UNIT

LMCS252



A STEELFORT PRODUCT



PROUDLY
NZ OWNED



TABLE OF CONTENTS

OPERATOR SAFETY	3
General Instructions	
Symbols	
FEATURES & TECHNICAL DATA	8
Accessories & Recommended Accessories	
OPERATION & ASSEMBLY	10
Mounting Guide Bar & Saw Chain	
Chain Tension	
Fuel & Oil Mixture	
Bar & Chain Lubrication	
Starting Engine (Cold or Warm)	
Stopping Engine	
Adjusting Carburetor	
Chain Brake	
Safety With Fallen Trees	
Bucking With or Without Support	
MAINTENANCE & STORAGE	20
Damaged/Worn/Loose Parts	
Check Chainsaw Lubrication	
Air Filter	
Fuel Filter	
Change Spark Plug	
Sharpening The Saw Chain	
Storage	
Transport	
TROUBLESHOOTING	24
WARRANTY	25

Thank you for purchasing our LawnMaster Chainsaw, the information container within this manual will help you to have many years of safe and trouble free use of this LawnMaster product .

OPERATOR SAFETY

SAFETY RULES

This manual contains important safety information and instructions to operate the LawnMaster Chainsaw.

PLEASE READ THIS MANUAL CAREFULLY BEFORE USING THE UNIT.

Failure to adhere to the safety instructions could result in property damage and/or serious personal injury.

This manual should be considered a permanent part of the chainsaw and should remain with the unit at all times. All information in this publication is based on the latest product information available at the time of printing.

Product Information and specifications can be altered and/or improved without notice. Content from this publication may not be reproduced without written consent.

DANGER

Indicates a hazardous situation which, if not strictly complied with, will result in substantial property damage and or serious injury.

WARNING

Indicates a hazardous situation which, if not strictly complied with, may result in property damage

CAUTION

Indicates a hazardous situation which, if not strictly complied with, could result in property damage or personal injury.

The warnings and precautions discussed in this manual does not cover all possible conditions and or scenarios that may occur.

It must be understood by the operator that common sense and caution must be taken into consideration

when operating this product, as these are factors which cannot be built into this manual.

DANGER

TOXIC FUMES

- The exhaust of the engine contains carbon monoxide, an odorless, colorless poison gas. Using the engine in confined/indoor spaces can be extremely dangerous and life threatening.

FIRE

- When operating the unit, the engine may create sparks that could trigger fires.
- When operating around dry vegetation such as agricultural crops, forest, bush, grass, or other similar environments please be careful.
- This engine may not be equipped with a spark arresting muffler. In some countries and regions, a spark arrester is required by law. Please contact your local council and or fire agency for laws and regulations relating to fire prevention requirements.
- Petrol is highly flammable and explosive. A fire and or explosion from petrol can cause severe burns or result in serious personal injury including death.
- Keep flammable items away while handling petrol. Fill fuel tank outdoors and in a well ventilated area with the engine stopped.
- Always wipe spilled fuel and wait until the fuel has dried before starting the engine.
- DO NOT operate the engine with known leaks in the fuel system. Use proper fuel storage and handling procedures.
- Empty the fuel tank before storing or transporting the chainsaw.
- Keep fire extinguisher handy at all times.

SAFETY POINTS FOR YOUR CHAINSAW

WARNING

The chainsaw is intended only for the cutting of wood. The engine group is intended only for use with the recommended cutting equipment.

Before using the machine, read the operating instructions carefully to understand all of the content. Failure to follow all instructions listed below may result in fire and/or serious injury. Only use this machine for usage specifically mentioned in this manual. **READ THE INSTRUCTIONS**

GENERAL INSTRUCTIONS

- Read this manual carefully until you completely understand and can follow all safety rules, precautions, and operating instructions before attempting to use the unit.
 - For adult use only. Restrict the use of your chainsaw to adult users who understand and can follow safety rules, precautions, and operating instructions found in this manual.
 - Wear protective gear, including steel-toed safety footwear, snug-fitting clothing, heavy-duty non-slip gloves, non-fogging vented goggles or a face screen, an approved safety hard hat, and sound barriers for hearing protection. Regularly check your hearing, especially if you use a chainsaw frequently. Secure hair above shoulder length.
 - Keep all parts of your body away from the chain when the engine is running.
 - Keep children, bystanders, and animals a minimum of 10 meters away from the work area. Do not allow other people or animals to be near the chainsaw when starting or operating the chainsaw. If necessary use warning signs to keep on lookers at a distance.
 - Do not handle or operate a chainsaw when you are fatigued, ill, or upset, or if you have taken alcohol, drugs, or medication. You must be in good physical condition and mentally alert. Chainsaw work is strenuous. If you have any condition that might be aggravated by strenuous work, check with your doctor before operating a chainsaw.
 - Carefully plan your sawing operation in advance. Do not start cutting until you have a clear work area, secure footing, and, if you are felling trees, a planned retreat path. Do not operate the chainsaw near a naked flame or spilled fuel. After re-fueling, always wipe off any spilled fuel, move the chainsaw away from the fueling point before starting the engine.
- Do not operate the chainsaw from a ladder or in a tree.
 - Make sure the chain will not make contact with any object while starting the engine. Never try to start the chainsaw when the guide bar is in a cut.
 - Do not put pressure on the chainsaw at the end of the cut. Applying pressure can cause you to lose control when the cut is completed.
 - Stop the engine before setting the chainsaw down.
 - Do not operate a chainsaw that is damaged, improperly adjusted, or not completely and securely assembled. Always replace bar, chain, hand guard, or chain brake immediately if it becomes damaged, broken or is otherwise removed.
 - With the engine stopped, hand carry the chainsaw with the muffler away from your body, and the guide bar and chain to the rear, preferably covered with a scabbard.
 - You must be in good physical condition and mental health and not under the influence of any substance (drugs, alcohol), which might impair vision, dexterity or judgment.
 - Clothing must be sturdy and snug-fitting, but allow complete freedom of movement. Avoid loose-fitting jackets, scarfs, neckties, jewelry, flared or cuffed pants, or anything that could become entangled with the chainsaw or brush. Wear overalls or jeans with a reinforced cutting resistant insert (A).
 - Protect your hands with gloves when handling a chainsaw. Heavy-duty, nonslip gloves improve your grip and protect your hands.
 - Good footwear is most important in chainsaw work. Wear sturdy boots with nonslip soles. Steel-toed safety boots are recommended.
 - Proper eye protection is a must. Non-fogging, vented goggles and a face screen is recommended. Their use reduces the risk of eye and facial injury.
 - Wear an approved safety hard hat to protect your head. Chainsaw noise may damage your hearing. Always wear noise protection equipment (ear plugs or ear muffs) to protect your hearing. Continual and regular users should have their hearing checked regularly.

OPERATE YOUR CHAINSAW SAFELY

- Do not operate a chainsaw with one hand. Serious injury to the operator, helpers, bystanders or any combination of these persons may result from one-handed operation. A chainsaw is intended for two-handed use. Always maintain a firm foothold. Ensure you are able to STOP the engine quickly if necessary.
- Operate the chainsaw only in a well-ventilated outdoor area.



MAINTAIN THE CHAINSAW IN GOOD WORKING ORDER

- Have all chainsaw servicing performed by a LawnMaster service dealer with the exception of the items listed in the maintenance section of this manual. For example, if improper tools are used to remove or hold the flywheel when servicing the clutch, structural damage to the flywheel can occur and cause the flywheel to burst.
- Make certain the chainsaw chain stops moving when the throttle trigger is released.

CARBURETOR ADJUSTMENT

- Never modify your chainsaw in any way.
- Keep the handles dry, clean, and free of oil or fuel mixture.
- Keep fuel and oil caps, screws, and fasteners securely tightened.
- It is recommended you use Genuine Parts to maintain your products.

HANDLE FUEL WITH CAUTION

- Do not smoke while handling fuel or while operating the chainsaw.
- Eliminate all sources of sparks or flame in the areas where fuel is mixed or poured. There should be no smoking, open flames, or work that could cause sparks. Allow engine to cool before refueling.
- Mix and pour fuel in an outdoor area on bare ground; store fuel in a cool, dry, well ventilated place; and use an approved, marked container for all fuel purposes. Wipe up all fuel spills before starting the chainsaw.
- Move at least 3 meters from fueling site before starting engine.
- Turn the engine off and let the chainsaw cool in a noncombustible area, not on dry leaves, straw, paper, etc. Slowly remove fuel cap and refuel unit.
- Store the unit and fuel in an area where fuel vapors cannot reach sparks or open flames from water heaters, electric motors or switches, furnaces, etc.

KICKBACK

WARNING

Kickback can happen if the moving saw chain in the upper quadrant of the bar nose hits a solid object or gets pinched. This causes a rotational

force in the opposite direction, potentially flinging the bar uncontrollably. This can lead to severe or fatal injuries, especially when the bar unexpectedly contacts solid material or is used incorrectly. Factors like chain speed, contact angle, and chain condition influence the force and occurrence of kickback.

WARNING

Use extreme caution when cutting small size brush and saplings which may easily catch the chain and pull you off balance.

TO AVOID PULL-IN (B)

Pull-in occurs when the chain on the bottom of the bar is suddenly stopped when it is pinched, caught or encounters a foreign object in the wood. The reaction of the chain pulls the chainsaw forward and may cause the operator to lose control.

Pull-in frequently occurs when the bumper spike of the chainsaw is not held securely against the tree or limb and when the chain is not rotating at full speed before it contacts the wood.

1. Always start a cut with the chain rotating at full speed and the bumper spike in contact with the wood.
2. Pull-in may also be prevented by using wedges to open the kerf or cut.

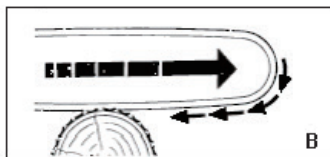

TO AVOID PUSH BACK (C)

Push back occurs when the chain on the top of the bar is suddenly stopped when it is pinched, caught or encounters a foreign object in the wood. The reaction of the chain drives the chainsaw straight back toward the operator and may cause loss of chainsaw control. Push back frequently occurs when the top of the bar is used for cutting.

1. Be alert to forces or situations that may cause material to pinch the top of the chain.
2. Do not cut more than one log at a time.
3. Do not twist the chainsaw when withdrawing the bar from a plunge cut or underbuck cut because the chain can pinch.

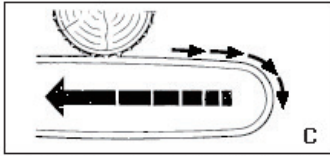

QUICK STOP CHAIN BREAK

WARNING

To reduce the risk of injury, stop using the chainsaw immediately if the chain brake does not function properly. Take the chainsaw to your LawnMaster Service Dealer! Do not use the chainsaw until the problem has been rectified. Chain brake is designed to stop the chain in the event of kickback. When the chain brake/hand guard is pushed towards the bar, the chain should stop immediately. A chain brake does not prevent kick-back; the chain brake should be cleaned and tested daily.

LOW KICKBACK CHAIN

"Low kickback saw chain" is a chain which has met the kickback performance requirements. Low-Kickback Chain, designed with a contoured depth gauge and guard link which deflect kickback force and allow wood to gradually ride into the cutter.

REDUCED KICKBACK BAR

Reduced-Kickback Guide Bar, designed with a small radius tip which reduces the size of the kickback danger zone on the bar tip. A Reduced-Kickback Guide Bar has been demonstrated to significantly reduce the number and seriousness of kickbacks.

TO AVOID KICKBACK

The best protection from personal injury that may result from kickback is to avoid kickback situations:

1. Hold the chainsaw firmly with both hands and maintain a secure grip.
2. Be aware of the location of the guide bar nose at all times.
3. Never let the nose of the guide bar contact any object. Do not cut limbs with the nose of the guide bar. Be especially careful when cutting small, tough limbs, small size brush and saplings which may easily catch the chain.
4. Don't overreach.
5. Don't cut above shoulder height.
6. Cut only one log at a time.

7. Use extreme caution when reentering a previous cut.
8. Do not attempt to plunge cut if you are not experienced with these cutting techniques.
9. Be alert for shifting of the log or other forces that may cause the cut to close and pinch the chain.
10. Maintain saw chain properly. Cut with a correctly sharpened, properly tensioned chain at all times.
11. Stand to the side of the cutting path of the chainsaw

SYMBOLS



Warning: Appropriate ear, eye and head protection must be worn



Hot surfaces will burn fingers or palms



Keep safe distance between user and machinery



No smoking and naked flames



Gloves with saw protection



Boots with saw protection, steel toecap and non-slip sole



Always grip the machine with two hands



Kickback: Never cut with the tip of the chainsaw.



Chain Brake Engage: Push to forward position



Chain Brake Disengage: pull back to locking position



Fuel and oil mixture



Chain oil fill/oil pump



Engine-manual start



Heated handle-temperature control



Choke-Open



Choke-Closed

FEATURES & TECHNICAL DATA

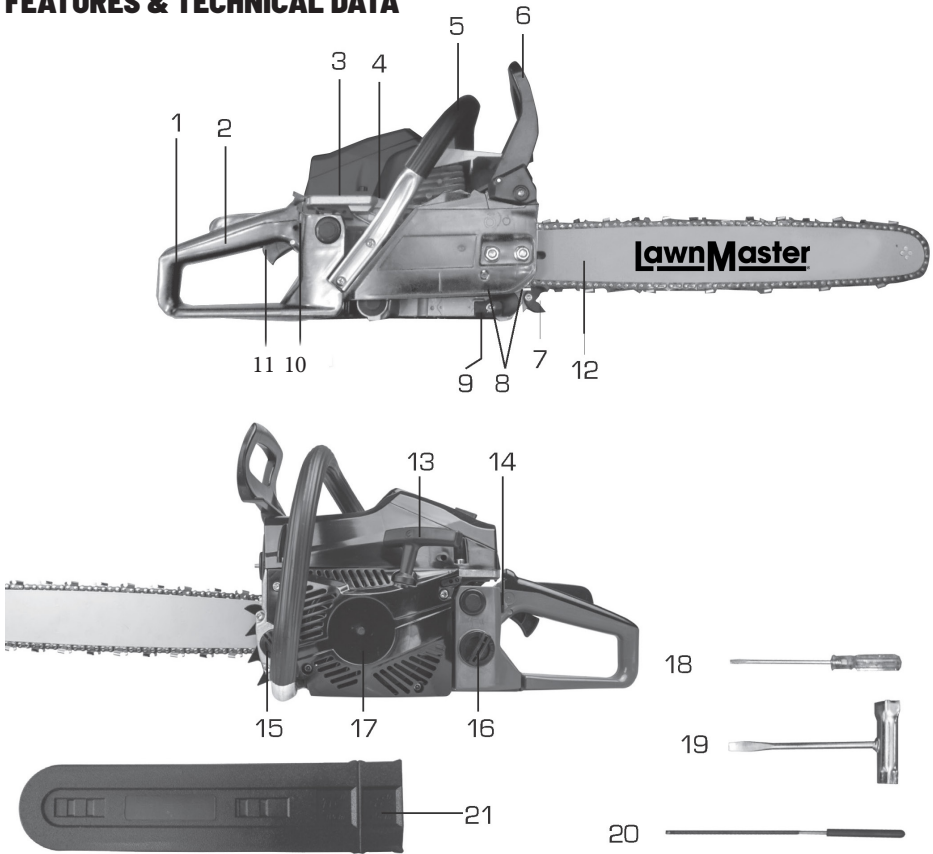

- | | | |
|----------------------------------|--------------------------|--|
| 1. Rear Handle | 10. Choke Lever | 19. Chain Adjustment & Spark Plug Tool |
| 2. Throttle Lockoff | 11. Throttle Trigger | 20. File |
| 3. Filter Hood Cap | 12. Guide Bar | 21. Chain Guard |
| 4. Filter Cover | 13. Starter Rope | 22. Clutch Cover (FIG.A) |
| 5. Front Handle | 14. Ignition Switch | 23. Chain Catcher (FIG.F) |
| 6. Chain Brake | 15. Chain Oil Filler Cap | 24. Chain (FIG.F) |
| 7. Spiked Bumper | 16. Fuel Mix Fill Cap | 25. Muffler (FIG.F) |
| 8. Chain Bar Locking Nuts | 17. Starter Housing | |
| 9. Chain Adjusting Screw (FIG.1) | 18. Screw Driver | |

ACCESSORIES

- | | |
|---------------------------|-----------------------------|
| 1x Blade protection cover | 1x Lubrication Oil |
| 1x Chain | 1x Chain Adjustment & Spark |
| 1x Guide Bar | 1x Plug Tool |
| 1x File | 1x Screwdriver |

RECOMMENDED ACCESSORIES

- Prime Parts 2 Stroke Premix Oil
1 Litre Bottle | PPOL015
- 1 Litre Chamber Bottle | PPOL019
- Prime Parts Chain Bar Lubricant
1 Litre Bottle | PPOL011

MODEL	LMCS252
Displacement (cc)	52cc
Power Rating (Kw/RPM)	2.5Kw/7500 RPM
Maximum RPM	12000 RPM
Idle Speed	2800-3200 RPM
Fuel Tank Capacity (ml)	550ml
Oil Tank Capacity (ml)	260ml
Bar Length (mm/inch)	500mm/20"
Chain Pitch	0.325
Chain Guage	0.058
Weight (kg)	5.8kg
Air Filter	Pleated Paper
Fuel Mix Ratio (First 10 Hours)	25:1
Fuel Mix Ratio (After Run)	40:1
Spark Plug Bosch/Champion	WSR6F/ RCJ6Y

KNOW YOUR CHAINSAW

IGNITION SWITCH (14)

The Ignition switch is used to stop the engine.

THROTTLE TRIGGER (11)

The throttle switch controls engine speed.

THROTTLE LOCK-OFF (2)

The throttle lock-off must be pressed before you can squeeze the throttle trigger. This feature prevents you from accidentally squeezing the trigger.

CHOKE LEVER (6)

The choke and fast idle are set by pulling the choke lever out to the full extent for cold starting or after refueling. The choke provides additional fuel to the engine during cold starting.

CHAIN BRAKE (6)

The chain brake is a device designed to stop the chain if kickback occurs. The chain brake activates automatically in the event of kickback. The chain brake activates manually if the front hand guard is pushed forward. The chain brake is disengaged by pulling the front hand guard back toward the front handle as far as possible.

CHAIN TENSION

It is normal for a new chain to stretch during the first 5 minutes of operation. Ensure the engine is always SWITCH OFF before fitting or adjusting the chain. You should check your chain tension frequently. See chain tension under the ASSEMBLY section.

ASSEMBLY

WARNING

Protective gloves should be worn during assembly. Never start the chainsaw before having mounted or regulated the chain.

MOUNTING THE GUIDE BAR AND SAW CHAIN

WARNING

If received assembled, repeat all steps to ensure your chainsaw is properly assembled and all fasteners are secure. Always wear gloves when handling the chain. The chain is sharp and can cut you even when it is not moving! Put the chainsaw on a stable surface and carry out the following steps for mounting the guide bar and saw chain: Release the chain brake

(6) by pulling the hand guard in direction of arrow. (Fig. A) Ensure the chain brake lever is in disengaged position.

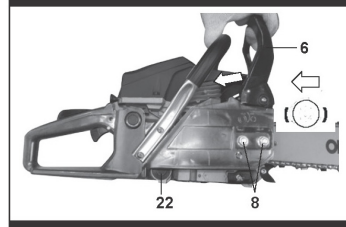

Fig. A

1. Unscrew the chain bar locking nuts (8) with Chain adjustment & Spark plug tool (19).
2. Pull off the clutch cover (22).
3. Install the Spiked bumper (7) to the power unit. (Fig. B)

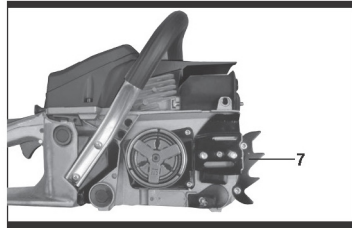

Fig. B

4. Put on the guide bar (12). (Fig. C)

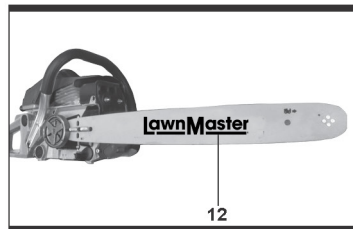

Fig. C

5. Carefully remove the chain from the package. Hold chain with the drive links as shown. Check the chain direction. (Fig. D & E)

WARNING

Cutters must face in direction of rotation.

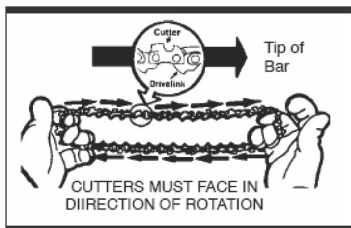

Fig. D

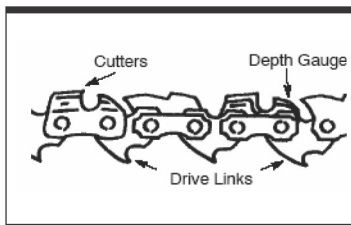

Fig. E

6. Lift the chain over and behind clutch retainer, fitting the drive links in the clutch drum sprocket. (Fig. F)

CAUTION

Do not insert the chain between the chain sprocket and the disc.

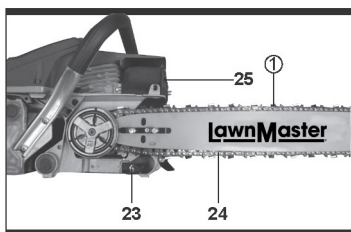

Fig. F

7. Fit bottom of drive links between the teeth in the front nose sprocket of the guide bar.
8. Fit chain drives links into chain bar groove (1). Place the chain (24) over the chain catcher (23) on the bottom.
9. Pull chain bar forward until chain is snug in chain bar groove. Ensure all drive links are in the bar groove.
10. Now, fit the metal spacer to the bar bolts, install clutch cover (22) making sure the adjusting pin (2) is positioned in the lower hole (3) in the

chain bar. Remember this pin moves the bar forward and backward as the screw is turned. (Fig. G)

11. Install the chain bar locking nuts(8) and tighten with Chain adjustment & Spark plug tool (19) only. Tension the chain as detailed in the next section. (Fig. H)

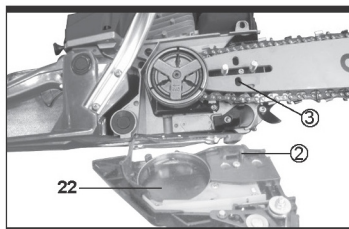

Fig. G

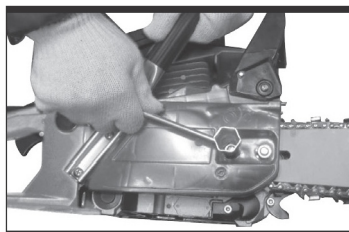

Fig. H

CHAIN TENSION

WARNING

Wear protective gloves when handling chain. The chain is sharp and can cut you even when it is not moving.

NOTE: When adjusting chain tension, make sure the chain brake nuts are finger tight only. Attempting to tension the chain when the chain brake nuts are tight can cause damage.

1. CHECKING THE TENSION

Use the end of the Chain adjustment & Spark plug tool (19) to move the chain(24) around guide bar(12) (Fig. I). If the chain is too tight, it will not rotate around the guide bar. If the chain is too loose, it will sag below the guide bar.



Fig. I

2. ADJUSTING THE TENSION (FIG.J)

Chain tension is very important. Chain stretch occurs during use. This is especially true during the first few times you use your chainsaw. Always check chain tension each time you use and refuel your chainsaw.

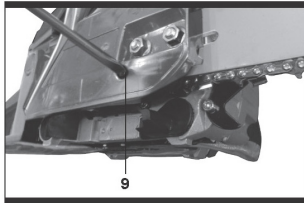

Fig. J

1. Loosen chain bar locking nuts (8) until they are finger tight against the clutch cover.
2. Turn chain adjusting screw (9) clockwise until chain solidly contacts bottom of guide bar rail.
3. Using the Chain adjustment & Spark plug tool (19), roll chain around guide bar to ensure all links are in bar groove
4. Lift up tip of guide bar to check for sag. Release tip of guide bar, then turn adjusting screw clockwise. Repeat until sag does not exist.
5. While lifting tip of guide bar, tighten chain bar locking nuts (8) securely with the Chain adjustment & Spark plug tool (19). (Fig K) **DO NOT OVER TIGHTEN**

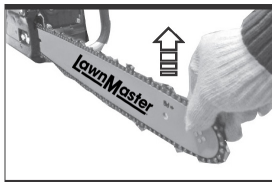

Fig. K

6. Use the end of the Chain adjustment & Spark

plug tool (19) to move chain around guide bar (Fig I).

7. If the chain is too tight, it will not rotate around the guide bar. Slightly loosen the chain bar locking nuts (8) and loosen the chain by turning the chain adjusting screw (9) counterclockwise. Re-tighten the chain bar locking nuts (8) if chain is too loose, it will sag below the guide bar. **DO NOT** operate the chainsaw if the chain is loose.

WARNING

If the chainsaw is operated with a loose chain, the chain could jump off the guide bar and result in serious injury.

OPERATION

BEFORE STARTING ENGINE

WARNING

Be sure to read the fuel handling information in the safety rules section of this manual before you begin. If you do not understand the fuel handling information do not attempt to fuel your unit. Seek help from someone that does understand the information.

FUELING & REFUELING ENGINE

WARNING

Always turn off engine before refueling. Never add fuel to the machine with a running or hot engine. Move at least 3m from the refueling site before start the engine. **DO NOT SMOKE** while refueling the engine, failure to follow this warning could result in serious injury or death

SAFETY TIPS FOR FUELING

- Always handle fuel with care. It is highly flammable.
- Always refuel outdoors where there are no sparks and flames. Do not inhale fuel vapors.
- Do not let petrol or oil come in contact with your skin.
- Keep petrol and oil away from the eyes. If petrol or oil comes in contact with the eyes, wash them immediately with clean water. If irritation is still present. Seek immediate medical help.
- Clean up spilled fuel immediately. Always store fuel in an approved container.

MIXING FUEL & OIL

WARNING

Read "Safety Tips for Fueling" before you begin.

1. This engine is designed to operate on unleaded petrol. This product requires pre-mixing petrol and 2-stroke oil. Pre-mix unleaded petrol and 2-stroke oil in the container provided.
2. Before operation, petrol must be mixed with a good quality synthetic 2-stroke air cooled engine oil designed to be mixed at a ratio between 25:1 to 40:1. It is recommended that you use Prime Parts oil for fueling your chainsaw.
3. DO NOT USE automotive or marine oil. These oils will cause engine damage. We recommend the use of Prime Parts Super 2 Stroke Oil.
4. Mix the fuel thoroughly each time and when refueling.
5. Mix in small quantities. Do not mix a quantity that is larger than can be quantities used in a 30-day period.
6. Petrol is highly flammable and extreme precautions must be taken when handling or working with petrol. Petrol should only be stored in approved containers.

Please follow the mixing method described below to ensure that the correct mixture is used with your chainsaw. Use the mixing container provided to mix the petrol and the oil. Use the funnel provided to prevent spillages.

1. Unscrew and remove the cap from the mixing container.
2. Pour unleaded petrol into the mixing bottle (not supplied) to the PETROL mark on the side of the container.
3. Pour oil into the mixing bottle (not supplied) to the OIL mark on the side of the container.
4. Refit and tighten the cap on the mixing container. Shake the container well to ensure that the petrol and oil is mixed together.

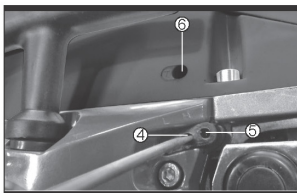

Fig. O

BAR & CHAIN LUBRICATION

The service life of the bar and chain depends on good lubrication. We recommend using Prime Parts Chainsaw Chain Oil. Otherwise it will result in damage to the bar, the chain and oil pump. The bar and chain require continuous lubrication. Lubrication is provided by the automatic oiler system when the oil tank is kept filled. Lack of oil will quickly ruin the bar and chain. Too little oil will cause overheating shown by smoke coming from the chain and/ or discoloration of the bar. Bar and chain oil must be free flowing for the oil system to pump enough oil for adequate lubrication. Never use waste oil for bar and chain lubrication. Always stop the engine before removing the oil cap. Refill the chain oil tank each time the chainsaw is refueled. To prevent possible restarting problems avoid running the fuel tank dry. This will help to extend engine life. We recommend the use of Prime Parts Chain Bar Lubricant.

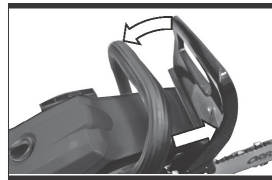

Fig.P1

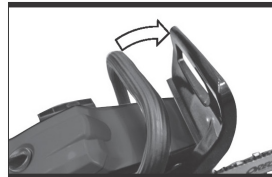

Fig.P2

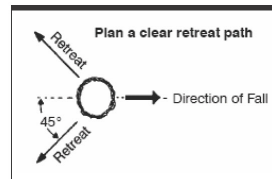

Fig.Q

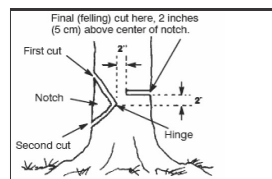

Fig.R

IMPORTANT

Experience indicates that alcohol-blended fuels (called gasohol or using ethanol or methanol) can attract moisture which leads to separation and formation of acids during storage.

Acidic gas can damage the fuel system of an engine while in storage. To avoid engine problems, the fuel system should be emptied before storage for 30 days or longer. Drain the gas tank, start the engine and let it run until the fuel lines and carburetor are empty. Use fresh fuel next season. See STORAGE section for additional information.

CHAIN BRAKE









Ensure chain brake is disengaged by pulling the front hand guard back toward the front handle as far as possible. The chain brake must be disengaged before cutting with the chainsaw.

WARNING

The chain must not move when the engine runs at idle speed. If the chain moves at idle speed refer to CARBURETOR ADJUSTMENT within this manual. Avoid contact with the muffler. A hot muffler can cause serious burns.

STARTING ENGINE

The chain brake must be disengaged when starting the chainsaw.

	COLD	HOT
Front chain brake lever	1 	1 
ON/OFF switch	2 	2 
Full choke position-CHOKE	3 	
Pull cord handle	4  x5	
Open choke position-START	5 	
Pull cord handle	6 	3 

The chainsaw is started on the ground. Make sure the chain brake is disengaged and place the chainsaw on firm level ground or other solid surface in an open area. Maintain good balance and secure footing.

Grip the front handlebar of the chainsaw firmly with your left hand and press down. For chainsaws with a rear handle level with the ground, put the toe of your right foot into the rear handle and press down. With your right hand pull out the starter pull cord slowly until you feel a definite resistance and then give it a brisk pull until the engine starts.

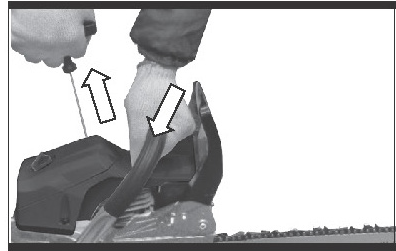

Fig. L

Your chainsaw has Easy-start construction, which helps to start the machine with minimum effort. When you pull the starter grip, don't wrap the starter rope around your hands. Do not allow the grip to snap back, but guide the starter rope slowly back to permit the rope to rewind properly. Failure to follow this procedure may result in injury to hand or fingers and may damage the starter mechanism.

IMPORTANT

When pulling the starter rope, do not use the full extent of the rope as this can cause the rope to break. Do not let starter rope snap back. Hold the handle and let the rope rewind slowly. For cold weather starting, start the unit at FULL CHOKE; allow the engine to warm up before squeezing the throttle trigger.

NOTE: Do not attempt to cut material with the choke/fast idle lever in the FULL CHOKE position.

STARTING A COLD ENGINE (OR WARM ENGINE AFTER RUNNING OUT OF FUEL)

NOTE: In the following steps, when the choke lever is pulled out to the full extent, the correct throttle setting for starting is set automatically.

1. Disengage the chain brake (6) by pull the hand guard.
2. Move Ignition switch to the "I" position. (Fig. M1)

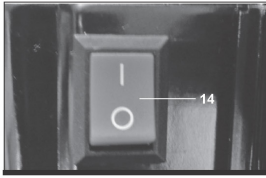

Fig.M1

3. Pull the choke lever (10) out to the full extent (to the FULL CHOKE position). (Fig. M2)

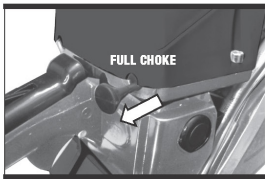

Fig.M2

4. Pull the starter rope (13) sharply 5 times with your right hand. Then, proceed to the next step. (Fig. L)

NOTE: If the engine sounds as if it is trying to start before the 5th pull, stop pulling and immediately proceed to the next step.

5. Push the choke lever (10) in to the OPEN Choke position. (Fig. M3)

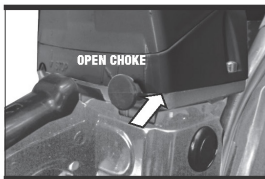

Fig.M3

6. Pull the starter rope(13) sharply with your right hand until the engine starts.
7. Allow the engine to run for approximately 5 seconds. Then, squeeze and release the throttle trigger (11) to allow engine to return to idle speed. The choke lever will in the OPEN CHOKE position. (Fig. M3)

STARTING A WARM ENGINE

1. Disengage the chain brake (6) by pull the hand guard.
2. Move Ignition switch to the "I" position.
3. Keep the choke lever(10) in the OPEN CHOKE position.
4. Pull the starter rope(13) sharply with your right hand until the engine starts.
5. Squeeze and release throttle trigger (11) to allow engine to return to idle speed.

STOPPING THE ENGINE

Move the Ignition switch (14) to the "0" position.

WARNING

DO NOT put the chainsaw on the ground when the chain is still moving. For additional safety, engage the chain brake when it is not in use.

CHECKING OIL SUPPLY (FIG. N)

Keep clear of the saw chain as it will start rotating upon starting of engine. After starting the engine, run the chain at medium speed and see if chain oil is scattered off as shown in the figure. The chain oil flow can be changed by inserting a screwdriver in the hole in bottom of the clutch side. Adjust according to your work conditions.

NOTE: The oil tank should become nearly empty by the time fuel is used up. Be sure to refill the oil tank every time when refueling the unit

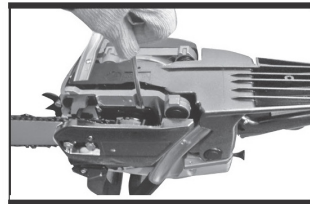

Fig.N

ADJUSTING CARBURETOR (FIG. O)

The carburetor on your unit has been factory adjusted, but may require fine tuning due to change in operating conditions. Before adjusting the carburetor, make sure that provided are clean air/ fuel filters and fresh, properly mixed fuel. When adjusting, take the following steps:

NOTE: Be sure to adjust the carburetor with the bar chain attached.

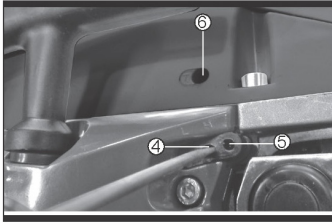

Fig. O

1. Stop engine and screw in both H and L needles until they stop. Never force. Then set them back the initial number of turns as shown below.

L NEEDLE: 1 1/4
H NEEDLE: 1 3/8

2. Start engine and allow it to warm up at OPEN-throttle
3. Turn L needle slowly clockwise to find a position where idling speed is maximum, then set the needle back a quarter (1/4) turn counterclockwise.
4. Turn idle adjusting screw (T) counterclockwise to that saw chain dose not turn. If idling speed is too slow, turn the screw clockwise.
5. Make a test cut and adjust the H needle for best cutting power, not for maximum speed.

CHAIN BRAKE (FIG. P1 & P2)

WARNING

If the brake band is worn too thin it may break when the chain brake is triggered. DO NOT USE IT. It must be replaced by the manufacturer, its service agent or similarly qualified persons in order to avoid a hazard.

With a broken brake band, the chain brake will not stop the chain. The chain brake should be replaced by a LawnMaster service dealer if any part is worn to less than 0.5 mm (0.020") thick. Repairs on a chain brake should be made by a LawnMaster service dealer.

- This chainsaw is equipped with a chain brake. The brake is designed to stop the chain if kickback occurs.
- The inertia-activated chain brake is activated if the front hand guard is pushed forward, either manually (by hand) or automatically (by sudden movement).

- If the brake is already activated, it is disengaged by pulling the front hand guard back toward the front handle as far as possible.
- When cutting with the chainsaw, the chain brake must be disengaged.

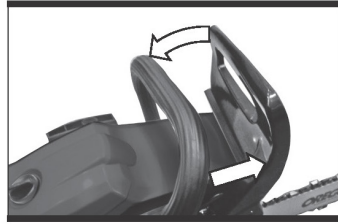

Fig. P1

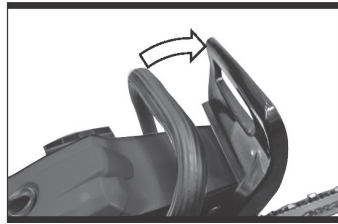

Fig. P2

BREAKING FUNCTION CONTROL

CAUTION

The chain brake must be checked several times daily. The engine must be running when performing this procedure. This is the only instance when the chainsaw should be placed on the ground with the engine running.

Place the chainsaw on firm ground. Grip the rear handle with your right hand and the front handle with your left hand. Apply full throttle by fully depressing the throttle trigger. Activate the chain brake by turning your left wrist against the hand guard without releasing your grip around the front handle. The chain should stop immediately.

OPERATING TIPS

- Check chain tension before first use and after 1 minute of operation. See CHAIN TENSION in the ASSEMBLY section.
- Cut wood only. Do not cut metal, plastics, masonry, nonwood building materials, etc.

- Stop the chainsaw if the chain strikes a foreign object. Inspect the chainsaw and repair or replace parts as necessary.
- Keep the chain out of dirt and sand prior to use. Even a small amount of dirt will quickly dull a chain and thus increase the possibility of kickback.
- Practice cutting a few small logs using the following techniques to get the “feel” of using your chainsaw before you begin a major sawing operation.
- Squeeze the throttle trigger and allow the engine to reach full speed before cutting.
- Begin cutting with the chainsaw frame against the log.
- Keep the engine at full speed the entire time you are cutting.
- Allow the chain to cut for you. Exert only light downward pressure. If you force the cut, damage to the bar, chain, or engine can result.
- Release the throttle trigger as soon as the cut is completed, allowing the engine to idle. If you run the chainsaw at full throttle without a cutting load, unnecessary wear can occur to the chain, bar, and engine. It is recommended that the engine not be operated for longer than 30 seconds at full throttle.
- To avoid losing control when cut is complete, do not put pressure on the chainsaw at end of cut.
- Stop the engine before setting the chainsaw down after cutting.

TREE FELLING TECHNIQUES (FIG. Q)

WARNING

Check for broken or dead branches which can fall while cutting causing serious injury.

Do not cut near buildings or electrical wires if you do not know the direction of tree fall, nor cut at night since you will not be able to see well, nor during bad weather such as rain, snow, or strong winds, etc. If the tree makes contact with any utility line, the utility company should be notified immediately.

- Carefully plan your sawing operation in advance.
- Clear the work area. You need a clear area all around the tree so you can have secure footing.
- The chainsaw operator should keep on the uphill side of the terrain as the tree likely to roll or slide downhill after it falls.
- Study the natural conditions that can cause the tree to fall in a particular direction.

Natural conditions that can cause a tree to fall in a particular direction include:

- The wind direction and speed.
- The lean of the tree. The lean of a tree might not be apparent due to uneven or sloping terrain. Use a plumb or level to determine the direction of tree lean.
- Weight and branches on one side.
- Surrounding trees and obstacles.

Look for decay and rot. If the trunk is rotted, it can snap and fall toward the operator. Check for broken or dead branches which can fall on you while cutting. Make sure there is enough room for the tree to fall. Maintain a distance of 2-1/2 tree lengths from the nearest person or other objects. Engine noise can drown out a warning call. Remove dirt, stones, loose bark, nails, staples, and wire from the tree where cuts are to be made. Plan a clear retreat path to the rear and diagonal to the line of fall.

LARGE FELLING TREES

(15 cm (6 inches) in diameter or larger) The notch method is used to fell large trees. A notch is cut on the side of the tree in the desired direction of fall. After a felling cut is made on the opposite side of tree, the tree will tend to fall into the notch.

NOTE: If the tree has large buttress roots, remove them before making the notch. If using the chainsaw to remove buttress roots, keep saw chain from contacting ground to prevent dulling of the chain.

NOTCH CUT AND FELLING THE TREE (FIG.R & S)

- Make notch cut by cutting the top of the notch first. Cut through 1/3 of the diameter of the tree. Next complete the notch by cutting the bottom of the notch. See illustration. Once the notch is cut remove the notch of wood from the tree.
- After removing the wood from the notch, make the felling cut on the opposite side of the notch. This is done by making a cut about two inches (5 cm) higher than the center of the notch. This will leave enough uncut wood between the felling cut and the notch to form a hinge. This hinge will help prevent the tree from falling in the wrong direction.

NOTE: Before felling cut is complete, use wedges to open the cut if necessary to control the direction of fall. To avoid kickback and chain damage, use wood or plastic wedges, but never steel or iron wedges.

- Do not cut in an area where logs, limbs, and roots are tangled such as in a blown down area. Drag the logs into a clear area before cutting by pulling out exposed and cleared logs first.

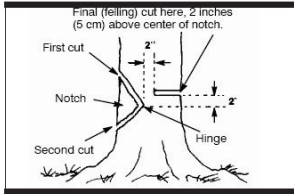

Fig.R

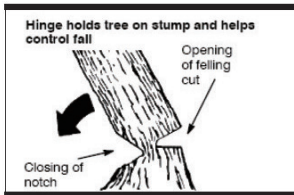

Fig.S

- Be alert to signs that the tree is ready to fall: cracking sounds, widening of the felling cut, or movement in the upper branches.
- As tree starts to fall, stop the chainsaw, put it down, and get away quickly on your planned retreat path.
- DO NOT cut down a partially fallen tree with your chainsaw. Be extremely cautious with partially fallen trees that may be poorly supported. When a tree doesn't fall completely, set the chainsaw aside and pull down the tree with a cable winch, block and tackle, or tractor.

CUTTING A FALLEN TREE (BUCKING)

Bucking is the term used for cutting a fallen tree to the desired log size.

WARNING

Do not stand on the log being cut. Any portion can roll causing loss of footing and control. Do not stand downhill of the log being cut.

IMPORTANT

- Cut only one log at a time.
- Cut shattered wood very carefully; sharp pieces of wood could be flung toward operator.
- Use a sawhorse to cut small logs. Never allow another person to hold the log while cutting and never hold the log with your leg or foot.

TYPES OF CUTTING USED FOR BUCKING

WARNING

If the chainsaw becomes pinched or hung in a log, don't try to force it out. You can lose control of the chainsaw resulting in injury and/or damage to the chainsaw. Stop the chainsaw, drive a wedge of plastic or wood into the cut until the chainsaw can be removed easily. Restart the chainsaw and carefully reenter the cut. To avoid kickback and chain damage, do not use a metal wedge. Do not attempt to restart your chainsaw when it is pinched or hung in a log. (Fig. T)

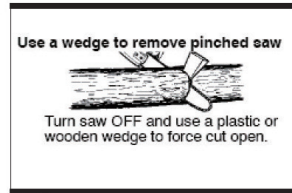

Fig.T

Over cutting begins on the top side of the log with the bottom of the chainsaw against the log. When over cutting use light downward pressure. (Fig. U)

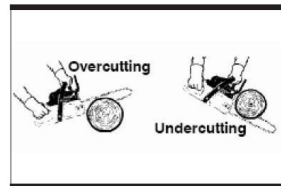

Fig. U

Undercutting involves cutting on the underside of the log with top of the chainsaw against the log. When undercutting use light upward pressure. Hold the chainsaw firmly and maintains control. The chainsaw will tend to push back toward you. (Fig. V1 & V2)

WARNING

Never turn the chainsaw upside down to undercut. The chainsaw cannot be controlled in this position. Always make your first cut on the compression side of the log. The compression side of the log is where the pressure of the log's weight is concentrated.

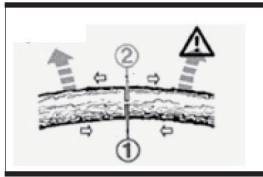

Fig.V1



Fig.V2

BUCKING WITHOUT A SUPPORT

- Over cut through 1/3 of the diameter of the log.
- Roll the log over and finish with a second over cut.
- Watch for logs with a compression side to prevent the chainsaw from pinching. See illustrations for cutting logs with a compression side.

BUCKING USING A LOG OR SUPPORT STAND (FIG. W1 & W2)

- Remember your first cut is always on the compression side of the log. (Refer to the illustrations below for your first and second cut)
- Your first cut should extend 1/3 of the diameter of the log.
- Finish with your second cut.

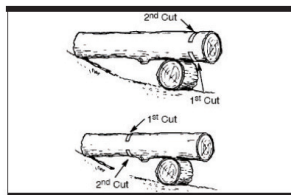

Fig.W1

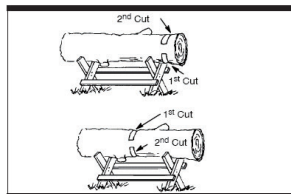

Fig.W2

LIMBING AND PRUNING

WARNING

Be alert for and guard against kickback. Do not allow the moving chain to contact any other branches or objects at the nose of the guide bar when limbing or pruning. Allowing such contact can result in serious injury. Never climb into a tree to limb or prune. Do not stand on ladders, platforms, a log, or in any position which can cause you to lose your balance or control of the chainsaw.

IMPORTANT

- Work slowly, keeping both hands firmly gripped on the chainsaw. Maintain secure footing and balance.
- Watch out for spring poles. Spring poles are small size limbs which can catch the saw chain and whip toward you or pull you off balance. Use extreme caution when cutting small size limbs or slender material.
- Be alert for spring back. Watch out for branches that are bent or under pressure. Avoid being struck by the branch or the chainsaw when the tension in the wood fibers is released.
- Keep a clear work area. Frequently clear branches out of the way to avoid tripping over them.

LIMBING

- Always limb a tree after it is cut down. Only then can limbing be done safely and properly.
- Leave the larger limbs underneath the felled tree to support the tree as you work.
- Start at the base of the felled tree and work toward the top, cutting branches and limbs. Remove small limbs with one cut.
- Keep the tree between you and the chain. Cut from the side of the tree opposite the branch you are cutting.
- Remove larger, supporting branches with the cutting techniques described in BUCKING WITHOUT A SUPPORT.
- Always use an over cut to cut small and freely hanging limbs. Undercutting could cause limbs to fall and pinch the chainsaw.

PRUNING (FIG. X)

WARNING

Limit pruning to limbs shoulder height or below. Do not cut if branches are higher than your shoulder. Get a professional to do the job. Make your first cut 1/3 of the way through the bottom of the limb.

Next make a 2nd cut all the way through the limb. Then cut a third over cut leaving a 1to2 inch (2.5 to 5cm) collar from the truck of the tree.

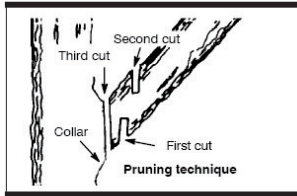

Fig.X

MAINTENANCE & STORAGE

WARNING

Disconnect the spark plug before performing maintenance except for carburetor adjustments. We recommend all service and adjustments not listed in this manual be performed by a LawnMaster Service Dealer.

CHECK FOR DAMAGED OR WORN PARTS

NOTE: It is normal for a small amount of oil to appear under the chainsaw after engine stops. Do not confuse this with a leaking oil tank.

- Ignition switch – Ensure Ignition switch functions properly by moving the switch to the "0" switch position. Make sure engine stops; then restart engine and continue.
- Fuel Tank – Do not use the chainsaw if fuel tank shows signs of damage or leaks.
- Oil Tank – Do not use the chainsaw if oil tank shows signs of damage or leaks.

CHECK FOR LOOSE FASTENERS AND PARTS

- Bar Nuts
- Chain
- Muffler
- Cylinder Shield
- Air Filter
- Handle Screws
- Vibration Mounts
- Starter Housing

- Front Hand Guard

CHECK CHAIN SHARPNESS

A sharp chain makes wood chips. A dull chain makes a sawdust powder and cuts slowly.

CHECK GUIDE BAR (FIG. Y1 & Y2)

Conditions which require guide bar maintenance:

- Chainsaw cuts to one side or at an angle.
- Chainsaw has to be forced through the cut.
- Inadequate supply of oil to bar/chain.

Check the condition of guide bar each time chain is sharpened. A worn guide bar will damage the chain and make cutting difficult. After each use, ensure Ignition switch is in the "0" position, then clean all sawdust from the guide bar and sprocket hole.

To maintain guide bar:

- Move Ignition switch to "0".
- Loosen and remove chain bar locking nuts (8) and clutch cover (22). Remove bar and chain from the chainsaw.
- Clean the oil holes and bar groove after each 5 hours of operation.
- Burring of guide bar rails is a normal process of rail wear. Remove these burrs with a flat file.
- When rail top is uneven, use a flat file to restore square edges and sides.

Replace guide bar when the groove is worn, the guide bar is bent or cracked, or when excess heating or burring of the rails occurs. If replacement is necessary, use only the guide bar specified for your chainsaw.

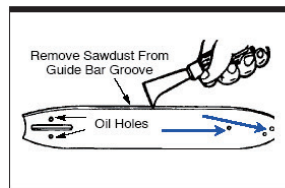

Fig.Y1

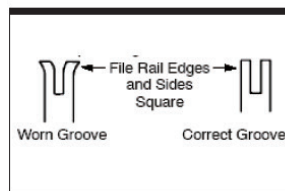

Fig.Y2

CHECK CHAINSAW LUBRICATION

- Start the Chainsaw
- Hold the running chainsaw approx 15cm above trunk or the ground (use appropriate base)
- If the lubrication is sufficient ,you will see a light oil trace because oil will be flung off the chainsaw NB If No oil trace is seen check chain Oil reservoir and clean the chainsaw from debris/dirt.

INSPECT AND CLEAN UNIT AND DECALS

- After each use, inspect complete unit for loose or damaged parts. Clean the unit and decals using a damp cloth with a mild detergent.
- Wipe off unit with a clean dry cloth.

CLEAN AIR FILTER (FIG. Z1&Z2)

CAUTION

Do not clean filter in gasoline or other flammable solvent to avoid creating a fire hazard or producing harmful evaporative emissions.

Cleaning the air filter:

A dirty air filter decreases the life and performance of the engine and increases fuel consumption and harmful emissions. Always clean your air filter after 10 tanks of fuel or 5 hours of operation, whichever comes first. Clean more frequently in dusty conditions. A used air filter can never be completely cleaned. It is advisable to replace your air filter with a new one after every 50 hours of operation, or annually, whichever comes first.



Fig. Z1

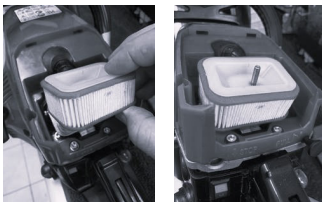

Fig. Z2

REPLACE SPARK PLUG

Cylinder fins (Fig. AA1)

Dust clogging between the cylinder fins will cause overheating of the engine periodically check and clean the cylinder fins after removing the air cleaner and the cylinder cover. When installing the cylinder cover, make sure that switch wires and grommets are positioned correctly in place.

NOTE: Be sure to block the air intake hole.

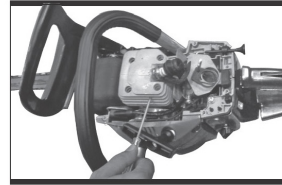

Fig. AA1

Spark plug (Fig. AA2)

Clean the electrodes with a wire brush and reset the gap to 0.65mm as necessary. The spark plug should be replaced each year to ensure the engine starts easier and runs better. Ignition timing is fixed and nonadjustable.

1. Loosen 3 screws on cylinder cover.
2. Remove the cylinder cover.
3. Pull off the spark plug boot.
4. Remove spark plug from cylinder and discard.
5. Replace with a new spark plug and tighten securely with a 3/4 inch (19mm) socket wrench. Spark plug gap should be 0.025 inch (0, 6 mm).
6. Reinstall the spark plug boot.
7. Reinstall the cylinder cover and 3 screws. Tighten securely.

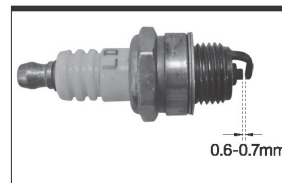

Fig. AA2

REPLACE FUEL FILTER

To replace fuel filter, drain your unit by running it dry of fuel. Remove fuel cap and its connected retainer from tank. Pull filter from tank and remove from line. Replace and reassemble.

SHARPENING THE SAW CHAIN

CAUTION

Before doing any work on the guide bar or chain, always switch off the engine and pull the plug cap off the spark plug (see "Replacing the spark plug"). Always wear protective gloves!

The chain needs sharpening when:

- The sawdust produced when sawing damp wood looks like wood flour.
- The chain penetrates the wood only under great pressure.
- The cutting edge is visibly damaged.
- The saw is pulled to the left or right when sawing. This is caused by uneven sharpening of the chain.

IMPORTANT:

Sharpen frequently, but without removing too much metal!

Cutter setting standards:

Before filing:

- Make sure the saw chain is held securely.
- Make sure the engine is stooped.
- Use a round file of proper size for your chain.
- Chain type: .325"
- File size: 3/16(4.5mm)
- Place your file on the cutter and push straight forward.
- Keep the file position as illustrated.
- Place your file on the cutter and push. Straight forward.
- Keep the file position as illustrated. (Fig. AA3& AA4)
- After each cutter has been filed, check the depth gauge and file it to the proper level as illustrated.

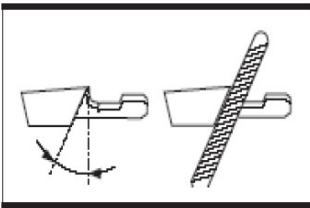

Fig. AA3

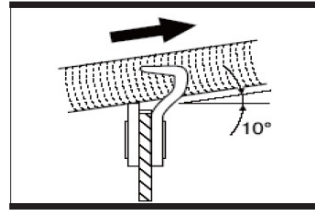
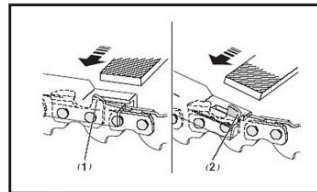

Fig. AA4

WARNING

Be sure to round off the front edge to reduce the chance of kickback or tie-strap breakage.

- Correct even the smallest excess height with a special flat file (1).
- Round off the front of the depth limiter (2).
- Depth gauge standard (3)



- Make sure every cutter has the same length and edge angles as illustrated.
- Cutter length (4).
- Side plate angle (5).
- Top plate cutting angle (6)

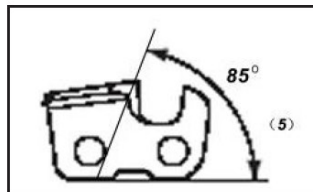
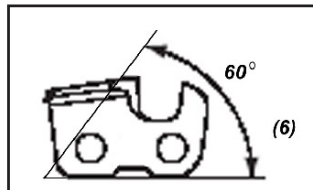

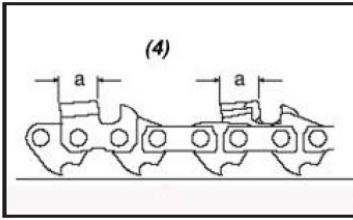

chain and bar covered with the chain guard. Properly secure your chainsaw to prevent turnover, fuel spillage and damage to the chainsaw. Make sure the chainsaw is not exposed to heat or sparks

STORING THE CHAINSAW

- Allow the engine to cool, and secure the unit before storing or transporting.
- Store chainsaw and fuel in a well ventilated area where fuel vapors cannot reach sparks or open flames from water heaters, electric motors or switches, furnaces, etc.
- Store chainsaw with all guards in place and position chainsaw so that any sharp object cannot accidentally cause injury.
- Store chainsaw well out of the reach of children.

SEASONAL STORAGE

Prepare your unit for storage at the end of the season or if it will not be used for 30 days or more.

- Clean chainsaw thoroughly before storage.
- Store in a clean dry area.
- Lightly oil external metal surfaces and guide bar.
- Oil the chain and wrap it in heavy paper or cloth.

TRANSPORTING THE CHAINSAW

WARNING

Always stop the engine before putting a chainsaw down or carrying it. Carrying a chainsaw with the engine running is extremely dangerous. Accidental acceleration of the engine can cause the chain to rotate. Avoid touching the hot muffler.

By hand: When carrying your chainsaw by hand, the engine must be stopped and the chainsaw must be in the proper position. The chain protection cover should be over the chain and the guide bar must point backwards. When carrying your chainsaw the bar should be behind you.

By vehicle: When transporting in a vehicle, keep

TROUBLESHOOTING

Before performing any maintenance or cleaning work, always turn off the engine and wait until the saw chain has come to a standstill.

THE ENGINE WONT START OR KEEP RUNNING

- Check that whether there is no fuel or be used out.
- Incorrect starting procedure— Follow the instructions
- Dirty spark plug or incorrect distance between the electrodes- Check the spark plug
- Air filter clogged- Clean and/or replace the filter
- Carburator problems- Contact local LawnMaster dealer
-

THE ENGINE STARTS BUT IS LACKING POWER

- Have fuel filter replaced - Contact local LawnMaster dealer
- Air filter clogged— Clean and/or replace the filter
- Carburator problems- Contact local LawnMaster dealer

THE ENGINE RUNS IRREGULARLY AND LACKS IN POWER WHEN REVVED

- Dirty spark plug or incorrect distance between the electrodes- Check the spark plug
- Carburator problems—Contact local LawnMaster dealer

THE ENGINE MAKES TOO MUCH SMOKE

- Incorrect composition of the fuel mixture- Prepare the fuel mixture according to the instructions.
- Carburator problems- Contact local LawnMaster dealer

THE CUTTING DEVICE MUST NOT MOVE WHEN THE ENGINE IS RUNNING IDLE

- Incorrect carburator regulation - Contact local LawnMaster dealer
-

THE MACHINE STARTS TO VIBRATE ABNORMALLY

- Damaged or loose parts- Stop the machine and disconnect the spark plug cable Inspect for damage. Check for and tighten any loose parts. Have all checks, repair work and replacements carried out by a LawnMaster Service Dealer.

IF THE TEMPERATURE OF MACHINES IS TOO HIGH

- Ensure the machines have rest at regular time.
- Faults which cannot be rectified with the aid of this table may be rectified by a LawnMaster Service Dealer.

WARRANTY

Subject to the following conditions, this unit is covered by a comprehensive two-year warranty.

The unit is designed for domestic purposes only, issues and faults due to commercial use may not be covered by warranty. The warranty covers all manufacturing faults but excludes normal wear and tear, misuse, neglect, accidental damage or defects arising from failure to comply with instructions as outlined in this owners manual. Only genuine spare parts can be used for repairs and this must be carried out by an authorised LawnMaster Services Dealer to maintain warranty.

Warranty does not cover the cost of transportation of any part(s) but does cover the labour/parts cost incurred in repairing or replacing any defective part(s) consequential or special damages and / or expenses resulting from any defect.

If the unit requires further repairs or services please visit www.lawnmaster.co.nz to find your local LawnMaster dealer.

For all other enquiries contact **Steelfort Customer Services +64 6 350 1350**

LawnMaster®

FIND US



www.lawnmaster.co.nz



lawnmasternz

Steelfort

500 Rangitikei Street, Private Bag 11045
Palmerston North, 4412, New Zealand
06 350 1350

Steelfort Auckland

880 Great South Road, Penrose
Auckland, 1061, New Zealand
09 573 1324